

DATA SHEET

BOX MOUNTED NEOTER SQUARE TOUCH THERMOSTAT

Internal code: NEOTSA

1. DESCRIPTION AND USE

The ambient room thermostat is a high-quality thermostat and is designed to display and adjust the desired temperature. Proper programming of the thermostat can provide annual savings of up to 10%.



2. TECHNICAL CHARACTERISTICS

- Temperature sensor: NTC
- **Dimensions**
- Temperature accuracy: ± 1 °C
- Energy consumption: < 1 W
- Voltage: 230 VAC 50/60Hz
- Load current: 3 A
- Temperature settings: 5~90 °C
- Keys: touch keys

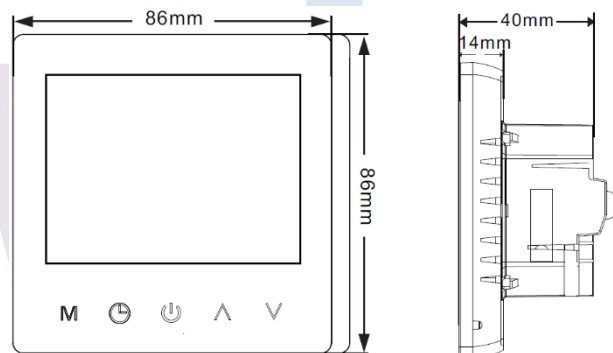

3. MOUNTING AND PROGRAMMING STAGES

1. Connect the power box according to the wiring diagram

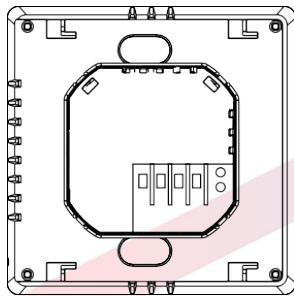

2. Push the panel up and remove the fixing plate

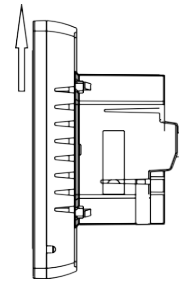

3. Mount with screws the fixed thermostat plate into the electrical connection box.

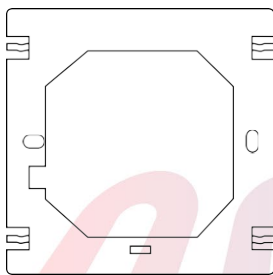

4. Place the panel in the fixed plate and push down

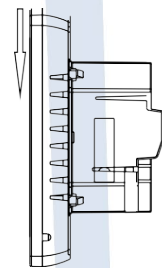

Recommended mounting location

The heating thermostat must be mounted on the wall in the area where the air flows freely around.
WARNING: The mounting location should not be influenced by other heat sources (e.g. sunlight), the airflow through doors and windows, or the exterior wall temperature.

Wiring diagram

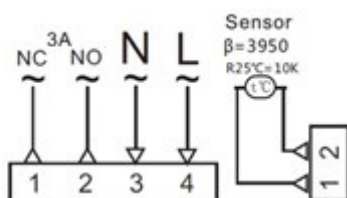

Note: For the NeoTer thermoelectric heads, code CAPA20405MK - 1W THERMOELECTRIC HEAD, the thermostat is connected to the control unit using 2, 3 and 4 according to the diagram above.

The following symbols are used for:

- ⏻ Power key: Touch the on/off key to turn on/off the system.
- M** Mode key, select the “period control mode” or the “manual mode” using this key.
- ^ v Up/down key: Touch the up and down keys to set the temperature and adjust the system parameters. The key lock function is entered by simultaneously pressing the up and down keys and holding them pressed for 5 seconds.
- 🕒 Clock key: Use this key to set the time and the days of the week.
- 🔒 Manual mode: Use this key to set the temperature manually.
- 🕒 Automatic mode: When set to the automatic mode, the thermostat will operate cyclically, according to the weekly program

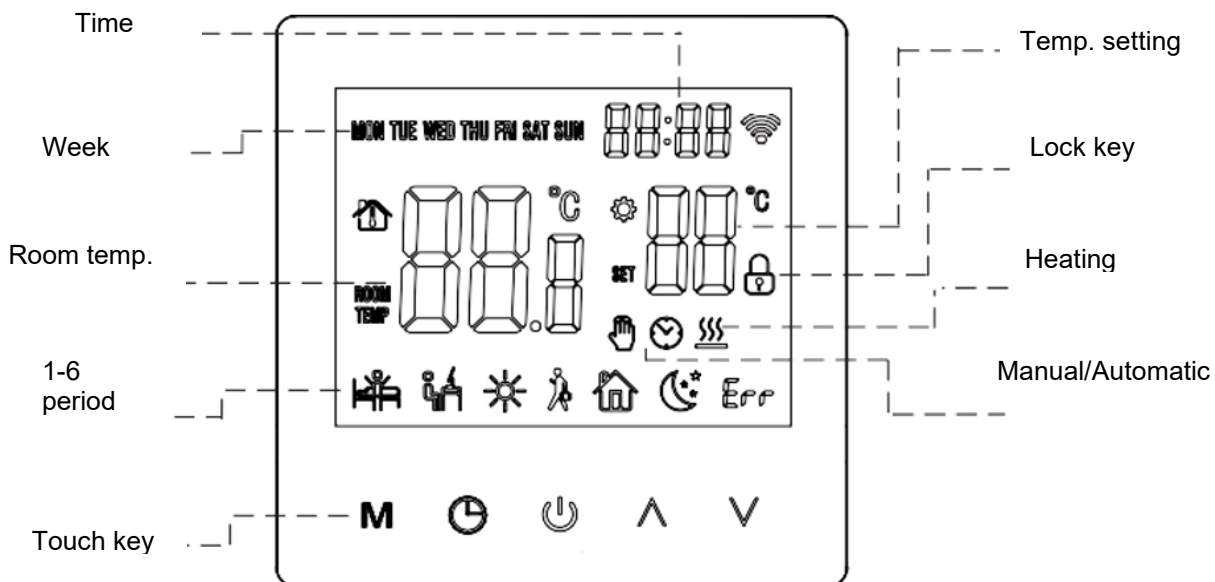









Thermostat programming

When off, long press the “M” mode key and the “🕒” clock key for 5 seconds to enter the programming mode. You can change the parameters using the mode key. After entering the programming mode, press the mode key to set the hour and, afterwards, the minutes. Press the mode key again to set the temperature.







1. Wake up 🏠
1. Leave 🚶
2. Return (a.m.) ☀️
3. Leave (p.m.) 🚶
4. Return (p.m.) 🏠
5. Sleep 🌙

Key	Event	Symbol	Hours	Default	^ v

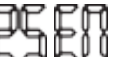
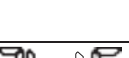
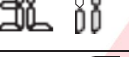
					AV		
M	Day of the week	01		06: 00	Time setting	20 °C	Temperature setting
		02		08:00		15 °C	
		03		11:30		15 °C	
		04		12:30		15 °C	
		05		17:00		22 °C	
		06		22:00		15 °C	
	Weekend	01		08:00		22 °C	
		02		23:00		15 °C	

Advanced setting (preferably by a qualified person)

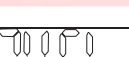
Press simultaneously “M” and “V” to immediately enter the advanced setting mode when the thermostat is off. The following seven functions can be selected using the “M” key.

Item	Symbol	Settings	Default	or
1		Temperature calibration	-2	Measured temperature range adjustment: -9~9 °C
2		Sensor mode	IN	IN: built-in sensor OU: floor sensor AL: both sensors
3		Overheating protection	60 °C	Adjustment range: 5 °C ~ 60 °C
4		Switching difference	1 °C	Switching difference range adjustment: 1 - 5 °C
5		Anti-freeze function	ON	On (01)/off (00) Anti-freeze function
6		Hourly mode periods	01	OF: Closed 01: Mode 5+2 days 02: mode 6+1 day 03: mode 7+0 day
7		Max. temperature	40	Adjustment range: 30 °C ~ 90 °C
8		Lower temperature limit setting	10	Adjustment range: 5 °C ~ 20 °C
9		Factory reset		Press Λ and hold for 5 s, all the parameters will be reset

Anti-freeze function

When off, the thermostat will automatically turn on the device when the room temperature drops below 5 °C. When the temperature is above 7 °C, the thermostat will automatically turn off the heating device.

Troubleshooting of frequent faults

Fault	Solution
Non-operational screen	1. Check if the power supply is wired correctly. 2. Check the power key.
Confusing LCD display	Housing deformed during assembly. It can be reinstalled.
Normal display No output	1. Check the wiring between the MPU and the supply board for damage 2. Check if the null or phase line is connected incorrectly.
Thermostat failure	Check the battery and replace it if necessary.
Temperature display error	Adjust the temperature display using the first option in the Advanced table
Faulty sensor	Check if the sensor is damaged Er1: Disconnected or faulty built-in sensor Er2 Disconnected or faulty external sensor.

5. WARRANTY PERIOD

The warranty period is 24 months from the date of delivery, provided that the customer/user fully complies with the transport, handling and installation rules.